

TIVOLI

mod-8823 / L2M

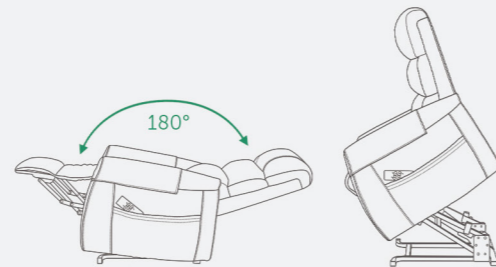

lift chair



PROGETTO[®]
RELAX

DIMENSIONS

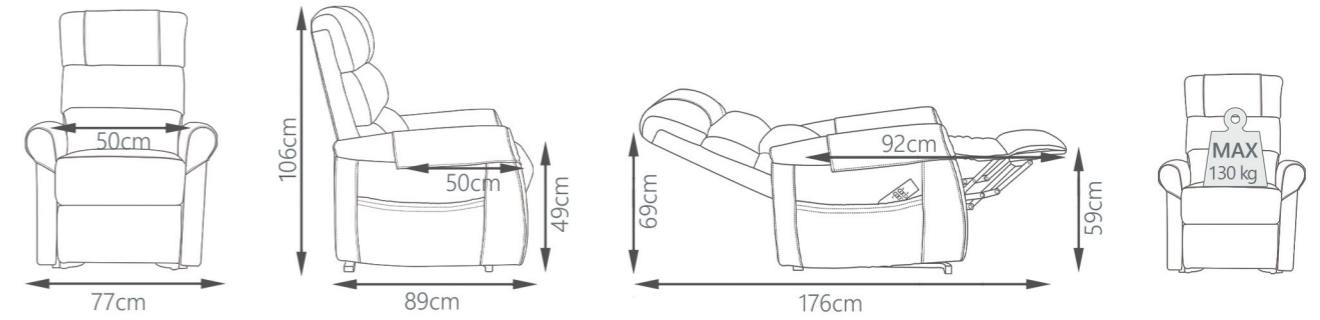

TIVOLI mod-8823

SPECIFICATIONS

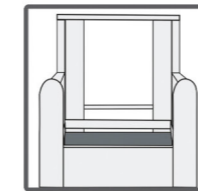

EN / FR

Solid wood and plywood
Bois massif et contre-plaqué

IT / DE

Legno massiccio e compensato
Massivholz und Sperrholz

NL / ES

Massief hout en multiplex
Madera maciza y madera contrachapada

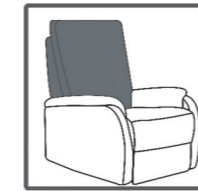

Webbing

Sangles élastiques

Cinch

Gurtband

Singelband

Cincha

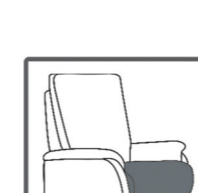

Sinusoidal springs
Ressorts nosag

Molle Nosag
Zig-zag Federn

Nosag veren
Muelles zig-zag

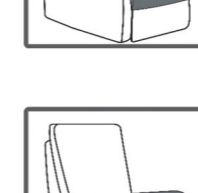

Pocket springs
Ressorts ensachés

Molle insacchettate
Taschenfedern

Pocket veren
Muelles ensacados

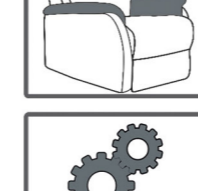

Polyurethane foam
Mousse de polyuréthane

Schiuma poliuretanic
Polyurethan Schaum

Polyurethaan schuim
Espuma de poliuretano

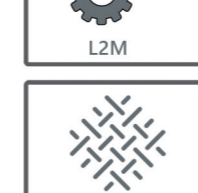

Polyurethane foam
Mousse de polyuréthane

Schiuma poliuretanic
Polyurethan Schaum

Polyurethaan schuim
Espuma de poliuretano



Recliner armchair with dual
motors power lift
Fauteuil releveur avec
bi-moteurs

Poltrona reclinabile lift
bi-motore
Relaxsessel 2-motorisch mit
Aufstehhilfe

Relaxfauteuil 2-motorig met
sta-op hulp
Sillón relax de 2 motores con
función elevadora

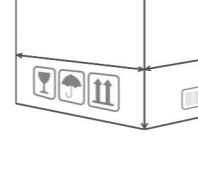

Fabric Cobra 100% polyester
Tissu Cobra, 100% polyester

Tessuto Cobra. 100% polyester
Cobra-Stoff, 100% Polyester

Stof Cobra, 100% polyester
Tela Cobra, 100% poliéster

COLLI 1/1

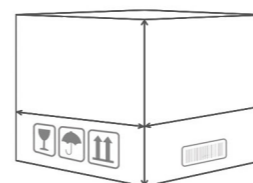

N.W.: 51,5 KG
G.W.: 57 KG
CBM.: 0,40 m³

78cm x 77cm x 66cm (LxWxH)

TIVOLI

lift chair



COLORS

FUNCTIONS



cobra



PC009 dark grey

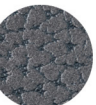

PC015 bronze

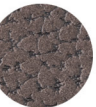

option / battery kit



lift



head- and armcover